

Tables based on ΔT 50 - mean water temperature in radiator of 70°C and room temperature of 20°C. ΔT 60 mean water temperature in radiator of 80°C and room temperature of 20°C. Radiator outputs to EN442 Standard.

Height	# Columns	Output Kw ΔT 50 ΔT 60	Height	# Columns	Output Kw ΔT 50 ΔT 60	Height	# Columns	Output Kw ΔT 50 ΔT 60	Height	# Columns	Output Kw ΔT 50 ΔT 60
300	2	0.024 0.030	750	2	0.055 0.069	1500	2	0.106 0.135	2500	2	0.180 0.229
	3	0.033 0.042		3	0.074 0.094		3	0.144 0.183		3	0.246 0.312
	4	0.042 0.053		4	0.100 0.126		4	0.194 0.247		4	0.322 0.409
	5	0.052 0.065		5	0.119 0.151		5	0.228 0.291		5	0.380 0.483
	6	0.062 0.078		6	0.144 0.183		6	0.276 0.351		6	0.452 0.576
400	2	0.031 0.039	900	2	0.065 0.082	1800	2	0.128 0.162	2800	2	0.204 0.259
	3	0.042 0.053		3	0.088 0.111		3	0.174 0.221		3	0.279 0.354
	4	0.055 0.070		4	0.119 0.150		4	0.232 0.295		4	0.362 0.458
	5	0.067 0.085		5	0.141 0.179		5	0.273 0.349		5	0.427 0.542
	6	0.081 0.102		6	0.171 0.217		6	0.329 0.419		6	0.506 0.644
500	2	0.038 0.048	1000	2	0.072 0.091	2000	2	0.142 0.181	3000	2	0.218 0.277
	3	0.052 0.065		3	0.097 0.123		3	0.194 0.246		3	0.302 0.383
	4	0.068 0.086		4	0.131 0.166		4	0.258 0.328		4	0.388 0.491
	5	0.082 0.104		5	0.155 0.197		5	0.303 0.387		5	0.459 0.583
	6	0.099 0.125		6	0.188 0.240		6	0.364 0.464		6	0.542 0.690
600	2	0.045 0.056	1200	2	0.086 0.108	2200	2	0.157 0.200	*Other heights available on request		
	3	0.061 0.076		3	0.116 0.147		3	0.214 0.272			
	4	0.081 0.102		4	0.157 0.198		4	0.283 0.360			
	5	0.097 0.122		5	0.185 0.235		5	0.333 0.425			
	6	0.117 0.149		6	0.224 0.285		6	0.399 0.508			

Each section width 46mm

Installing dimensions De Longhi Steel tubular radiators

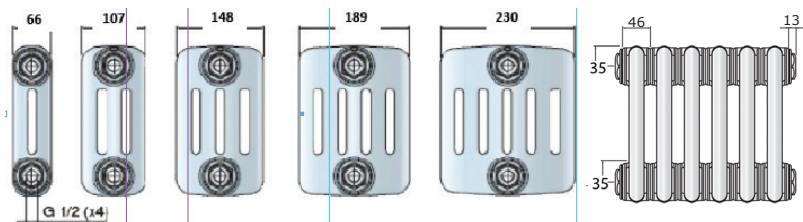

Optional installation with feet (available at extra cost)

Type A foot for 2 column

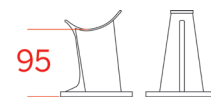

Type B foot for all other sections



*Connection possibilities

standard

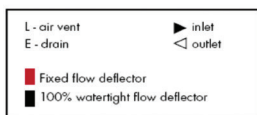
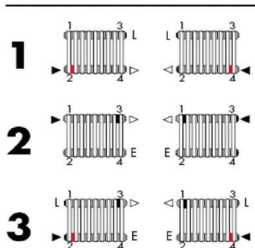

The standard configuration has four 1/2" reductions and one 1/2" pre-mounted blanking plug.

from/to upper side/lower side

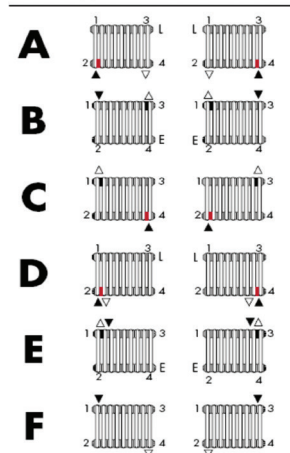

centre connection

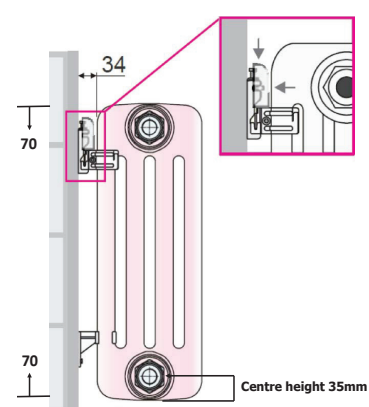
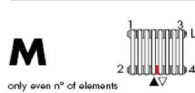

GBT wall bracket

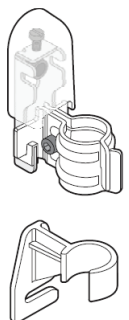

Centre of noggins 70mm from top of radiators. Suggested size for noggins; 90mm x 45mm framing timber